



Your Mercedes-Benz & HS-Schoch:

This must be love.

HS Schoch
Truck accessories/truck styling



This must be love.

Being a trucker means much more than just driving day after day from A to B and back via C. Being a TRUCKER means your job is your vocation in life.

For a real truck driver, his truck is not only his workplace or tool, it is his »home from home«, his daily companion.

En route on strange roads in foreign countries, his truck is often his only comrade in the long lonely nights.

No wonder real attachment grows. Two that belong together can get very close.

And of course every driver wants to be seen on the road with a truly attractive companion. One that is so eye-catching that it steals the show from other road-users.

For all this and more, **HS-Schoch** is the right address. Especially our exclusive stainless steel range makes trucker hearts beat faster – and converts »dull«, often inconspicuous trucks into true personalities.

Bull-catchers, lamp brackets, sidepipes, wheel accessories and compressed air horns made of finest V2A stainless steel ensure you make a distinctive, spectacular impact.

This catalog also contains high tops, cab bunks, spoilers, sun-screens, stowage facilities and a huge range of other practical articles which aim at making life easier and ensuring your safety on the highway.

**All based on the HS-Schoch motto:
»Quality over price«**

You're in for a pleasant surprise.

HS Schoch

Truck accessories/truck styling



Actros MP2 / Actros	415
Atego, Axor, LN2	61
Sprinter, Vito, Vario, SK	17
Made by HS-Schoch / EK1000	819
PK2000 evolution	10111





Actros MP2

More than a feeling

Truck-styling puts your truck in the limelight, turning it into an impressive visiting card its owner can be proud of.

Bull-catchers MP2 LH TÜV certification

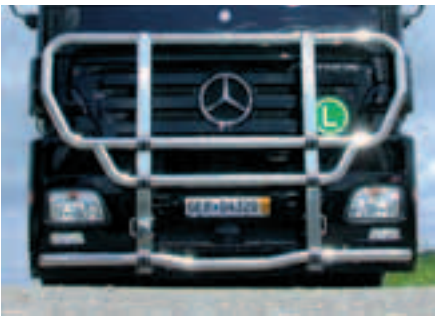

MEGA Order No. **5002 7215**
MEGA L-Cab No. **5002 7216** (Figure similar)

Mini-bulli-catcher MP2



Order No. **5002 3233**
Lowliner Order No. **32312**

Work platform MP2



Order No. **2000 0114** Mail order version without substructure. Paint finish in vehicle colour possible
 Can be mounted by us at extra charge.

BumpBar MP2



MP2, LH Order No. **1750 1006**

Root-wood trim MP2



Root-wood trim 11-piece
 Order No. **1020 0034**
 fibre, aluminium and fashion look.
 Ask us.

Consoles MP2



Console **centre**
 Root-wood Order No. **1021 0216**
 black Order No. **1021 0215**



Console **centre Telematics**
 black Order No. **1021 0219**
 Root-wood Order No. **1021 0220**

Spotlamp bar MP2



bottom Order No. **1650 4019**

Consoles MP2



Console **XXL**
 black Order No. **1021 0221**
 Root-wood Order No. **1021 0222**



Console **XXL Telematics**
 black Order No. **1021 0223**
 Root-wood Order No. **1021 0224**



Console **right**
 Root-wood Order No. **1021 0218**
 black Order No. **1021 0217**

Wind deflector MP2

Wind deflector with clips
MP2 Order No. **5001 0024**

Hub caps



Hub cap normal
 50mm **1650 2000**
 centre 170mm
 Steel rim **1650 2021**
 Alu rim **1650 2022**
 hoch 240mm
 Steel rim **1650 2016**
 Alu rim **1650 2017**

Cover rings

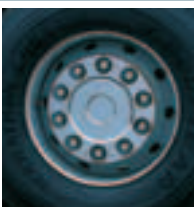

Cover ring, closed
 For aluminium + steel rim
6-hole 17,5": **1650 1802**
8-hole
 17,5"+19,5": **1650 1805**
Steel rim
 22,5": **1650 1800**
Alu rim
 22,5": **1650 1801**



Cover ring, open
 For aluminium + steel rim
 17,5": **1650 1806**
Steel rim
 22,5": **1650 1803**
Alu rim
 22,5": **1650 1804**

wheel liners



wheel liners
 (without cover ring)
 22,5" Standard,
 with fixing ring,
 depth 40mm
8060 42090

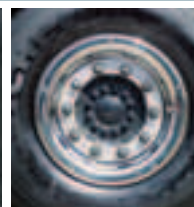

wheel liners at the rear
 22,5" Exklusive,
 with fixing ring,
 depth 80mm
8060 42095

Ornamental hub caps

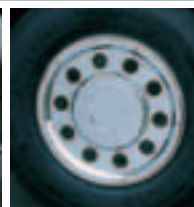

Ornamental hub cap Rear axle
 17,5": **8060 32045**
 19,5": **8060 32035**
 22,5" Rear axle &
 Super Single front:
8060 32055

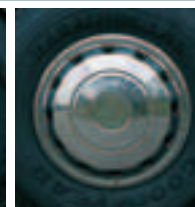

Ornamental hub cap Front axle
 17,5": **8060 32040**
 19,5": **8060 32030**
 22,5": **8060 32050**



All stainless **steel parts** are mirror-polished by hand.

Spare wheel carrier on page 9.
A wide selection of stowage boxes are shown on page 10111.

Bull-catchers Quick mounting. Mounting on original points. TÜV certification



LH Bull-catcher MEGA
Order No. **5002 7210**

Also available without lower bracket.



L Bull-catcher MEGA
Order No. **5002 7212**

Also available without lower bracket.

fully rotating lamp

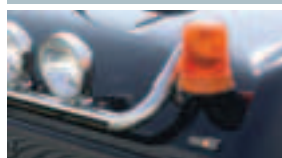

Order No. **2RL00806 1111**
Fixing plate for all-round light,
with clamp No. **1650 2999**

Work platform

On request

Spotlamps V2A stainless steel, light bulb not included



Bosch Navigator Ø211 mm, code no. 37,5
clear Order No. **3674 1526** **blue** No. **3674 1527**
Worklamp without code number
clear Order No. **3674 1528**



HELLA Luminator Chromium Celis, spotlight
with LED sidelight ring, Ø 224mm, code no. 37,5
clear Order No. **3674 3211**
HELLA Rallye 3000 Blue, code no. 30: **3674 3221**

Stainless steel adapter plate for HELLA Luminator
Chromium Celis Spotlamp bar **bottom** Order No. **1650 02998**
Clamp fitting for mounting spotlamp
60mm Order No. **2000 1430** 76mm Order No. **2000 1431**

Wind deflector

Side-window Wind deflector with clips
Actros Order No. **5001 0019**

Set of floor mats Actros

right/left, black/red/blue No. **1020 0126**

Wheel nut caps



RMK 27: **1650 1090**
RMK 30: **1650 1100**
RMK 32: **1650 1210**
RMK 33: **1650 1310**
Lamp cowling
Order No. **1650 3000**

Aerokit / 3D Roof spoiler



Aerokit
M- and low L-Cab Order No. **103010 1243**
L-Cab top Order No. **103010 1244**
Mega Space Order No. **103010 124K**
3D Roof spoiler
S, M, L Cab flt Order No. **160006 1245**
L-Cab high Order No. **160006 1246**

Consoles



Console **centre**
Root-wood Order No. **10210212**
black Order No. **10210211**



Console **right**
black Order No. **10210213**
Root-wood Order No. **10210214**

Root-wood trim



Root-wood trim 44-piece
Order No. **1020 0024**

Sun visor

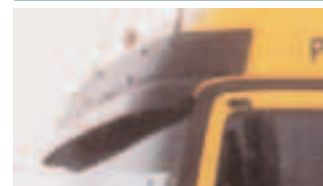

special with support, **Mega Space,**
L-Cab Order No. **1700 5028**
L-Cab flat Order No. **1700 5029**



Ornamental hub cap Grand Prix,
Front axle
22,5": **8060 42050**



Ornamental hub cap Grand Prix,
Rear axle
22,5": **8060 42055**



Ornamental hub cap at the front
Grand Prix
19,5" with fixing ring
8060 42030
17,5" with fixing ring
8060 42040



Ornamental hub cap at the rear
Grand Prix,
19,5" with fixing ring
8060 42035
17,5" with fixing ring
8060 42045



Ornamental hub cap at the rear
22,5" Exklusive,
10-hole
with fixing ring,
depth 130mm
8060 42065



Ornamental hub cap at the rear
22,5" Exklusive,
with wheel nut caps,
with fixing ring
8060 42075



Ornamental hub cap at the rear
22,5" open, with fixing
ring **8060 42080**



Your Truck – your style

Atego, Axor
LN2

You will be recognized by your truck. Bull-catchers, lamp brackets, sidepipes and numerous other accessories give standard trucks real character.

Bull-catcher



Bull-catcher **STANDARD**
Order No.: **5002 1216**

Spotlamp brackets



Spotlamp bar **top**, without Spotlamps
Atego Flat roof Order No. **1650 3009**
Atego/Axor High-top incl. clamps **1650 3025**
Spotlamps page 26/27

Sleeping pods



Type K Fh short Order No. **21001 30412**
Type E Routier Imp. short cab
Order No. **21000 20126**
Type N Fh short Order No. **21001 30406**

Sun visor



Sun visor special with support
Atego Normal roof
Order No. **1700 5120**

3D Roof spoiler



Type N, adjustable, short cab
Order No. **160006 0000**

3D Roof spoiler



Type K short and long cab,
adjustable as original
Order No. **1030 0114**

Type K Blade-type spoiler
(Top made of original spoiler)
short, long, high cab
640–860mm
Order No. **1030 0117**

Consoles Atego / Axor



centre black Order No. **1021 0251**



centre Root-wood Order No. **1021 0252**

Root-wood trim Atego



51-piece Order No. **1020 0033**

Truck interior outfits also available in carbon fibre, aluminium and fashion look. Ask us.

LN2

Bull-catchers		Sleeping pods Type N	
Bull-catcher LN2	5002 1212	Built-on-pods LN2/T2 short	210013 0404
3D spoiler Type N		Built-on-pods LN2/T2 long	210013 0405
3D spoiler LN2/T2 short (Type 26)	160005 0007	Sleeping pods Type K	
3D spoiler LN2/T2 long (Type 26)	160005 0008	Built-on-pods LN2/T2 kz.	210023 0404
side elements 3D spoiler LN2/T2 short	160005 0017	Aerokit	
Front spoiler		LN2/T2 short	1600 0115
Front spoiler with entry panel	1502 0022	LN2/T2 long	1600 0116
Sleeping pods Type E		Sun visor special with support	
AB-pods Type Routier Imp. LN2/T2 short	2100 0106	LN2 709-1320 short	1700 5022
AB-pods Type Routier Imp. LN2/T2 long	2100 1108	LN2 709-1320 long	1700 5023

Sprinter Vito, Vario SK



All stainless **steel parts** are mirror-polished by hand.

Wheel accessories on page 415.

Spare wheel carrier on page 9.
A wide selection of stowage boxes are shown on page 10111.

Bull-catchers Quick mounting. Mounting on original points. TÜV certification



Vito small Order No. **5002 7211**



Sprinter
small until model 99 Order No. **5002 7207**
small until model 00 Order No. **5002 7213**

Spotlamp brackets



Spotlamp bar, **High-top**
Order No. **1650 3023**

3D Roof spoiler Sprinter model 2006



650 mm high Order No. **1600 011064**
840 mm high Order No. **1600 011065**

Type N

600 mm high Order No. **1600 050018**
900 mm high Order No. **1600 050039**
400-640 mm high Order No. **1600 050040**

Sleeping pod



Type N small Sprinter
Order No. **21001 30403**
Type K small Sprinter
Order No. **21002 30406**

3D Roof spoiler



Type N Sprinter 208D-314D
Double cab Order No. **1600 050018**



Type K
Sprinter 208D-314D
Order No. **1030 0112**



Type N Sprinter 26.26B
Order No. **160005 0006**
Sprinter adjustable 30.26
Order No. **160005 0016**
Sprinter side elements
Spoiler
Order No. **160005 0014**

Sun visor



Vario T2
High-top Order No. **1700 5025**
Normal roof Order No. **1700 5024**

Sprinter Panel truck / flatbed truck
Order No. **1700 3047**

SK

Bull catcher

Narrow cab **5002 5204**

Wide cab **5002 5205**

Sleeping pods Type E

Built-on-pods Type Routier Imp. nG (SK) medium **2100 0109**

Built-on-pods Type Routier Imp. nG (SK) short **2100 2108**

Built-on-pods Type Routier Imp. nG (SK) long **2100 2110**

Sun visor special with support

1013-2636 (Cab. 381/3/5/7 short) SK **1700 5020**

1013-2635 (Cab. 381/3/5/7 long) SK3 **1700 5021**

1628 S-2644 S (Cab. 389) SK **1700 5026**

Compressed air horns



Super Fanfare Type BEAM
80+85 cm Order No. **5121 7701**
65+70 cm Order No. **5121 7702**

Original HS 67+76 cm
Order No. **5000 0000**

Universal



3D spoiler
T2, LN2, Vario, SK (corresponding original MB spoiler)
Order No. **1601 030015**

Made by HS-Schoch

Even in times like these when the range of products is more diversified and extensive than ever before, it is important to know who one is dealing with.

With **HS-Schoch** you are always on the safe side. Take advantage of our long experience and our know-how in truck accessories that we have acquired and advanced over the years.

Our products are developed in close cooperation with the manufacturers of utility vehicles, ensuring that our accessories are optimally coordinated to the specific vehicles and comply with the latest design and safety standards.

All **HS-Schoch** bull-catchers, lamp brackets, sidepipes, etc. have been developed and are produced in our own works.

This ensures that you are always close to base.

Especially our stainless steel range will give your truck that special "plus" and is guaranteed to attract attention. Quality workmanship and top design, with everything mirror-polished by hand make sure of that.

But these are only a few of the reasons for choosing products from **HS-Schoch**.

HS-Schoch means quality at fair prices. And our high standard of quality extends not only to our products, but also to our service.

With us, you are definitely on the safe side.



HS Schoch

Truck accessories/truck styling



Simple and secure ...

EK1000 spare wheel carrier from HS-Schoch

- Simple to mount on the trailer framework
- Simple to fasten and remove the spare wheel
- Highly reliable and strong due to using square sections
- Fits on practically all types of trailer
- Two wheel carriers can be mounted at the same time
- Excellent corrosion protection by cathodic electro-dipcoating and zinc phosphating
- Powder-coated in RAL 9005 – other RAL colors available on request
- Available for 22.5" wheels with and without offset
- Total weight 22 kg



Spare wheel carrier EK1000 for 22,5" wheel liner Order No. **2100 6120**
Clamping range 320mm Order No. **2100 6320**
Clamping range 220mm Order No. **2100 6220**

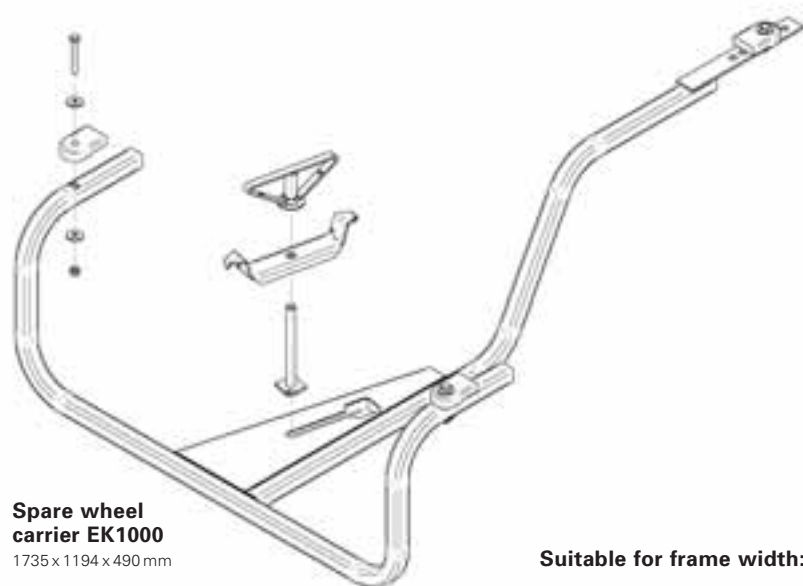

Spare wheel carrier EK1000
1735 x 1194 x 490 mm

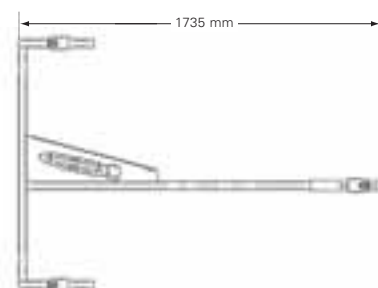

Suitable for frame width:

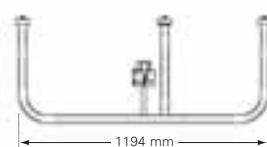
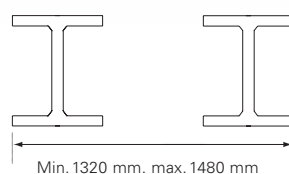



All aboard

No journey can really start until everything is »on board«. And in a context applicable for freight traffic, the proverb »As you make your bed, so you must lie in it« could be adapted to »As you load your truck, so you will travel«. To ensure that you can travel the roads of Europe safely and with confidence, **HS-Schoch** have developed perfect stowage systems you can rely on.

Pallet stow box PK2000 evolution light empty weight, low structural height and long service life; TÜV certification

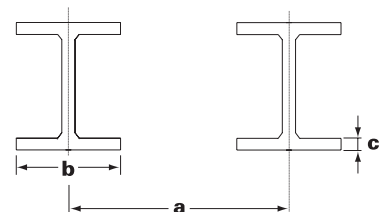
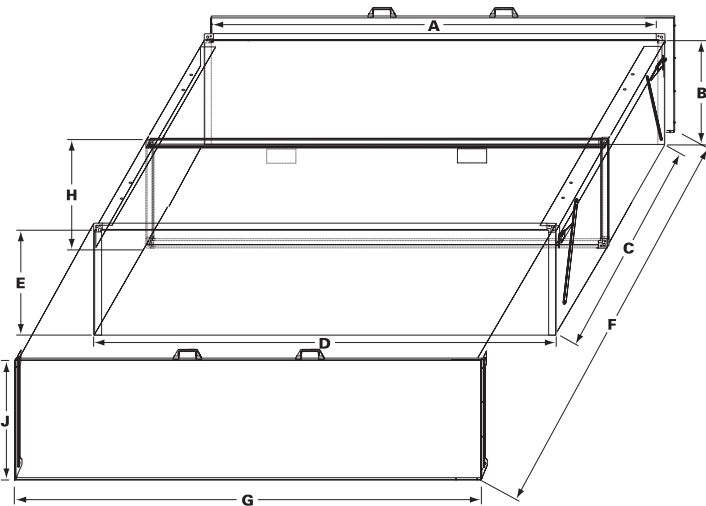
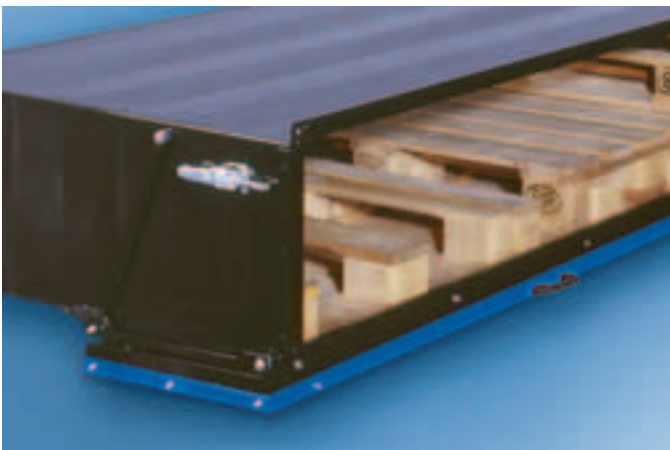

Drilling dimensions/Installation instructions:

Please specify the three dimensions shown in the sketch when you place your order: (a) = centre-to-centre distance between frame members; (b) = lower flange width; (c) lower flange thickness. The stretch clamps supplied allow you to bolt the boxes underneath any trailer or semi-trailer.

Measure H:

Dimension from lower edge of member to lower edge of pallet storage box.

Dimension E:

Protracted dimension from bottom edge of support to pallet storage box in loading range.

Order No.	Designation	A	B	C	D	E	F	G	H	J
PK20000800E1	PK 08 EP	1230	450	2450	1310	482	2490	1351	500	550
PK20000803E1	PK 08 EPL	1520	450	2450	1600	482	2490	1641	500	550
PK20001600E1	PK 16 EP	1960	450	2450	2040	482	2490	2081	500	550
PK20002000E1	PK 20 EP	2460	450	2450	2540	482	2490	2581	500	550
PK20002400E1	PK 24 EP	2630	450	2450	2710	482	2490	2751	500	550
PK20002401E1	PK 24 EPK	1960	605	2450	2040	637	2490	2081	655	700
PK20003000E1	PK 30 EP	2630	560	2450	2710	592	2490	2751	610	650
PK20003001E1	PK 30 EPK	2460	605	2450	2540	637	2490	2581	655	700
PK20003200E1	PK 32 EP	3430	450	2450	3510	482	2490	3551	500	550
PK20003600E1	PK 36 EP	2630	605	2450	2710	637	2490	2751	655	700



PK2000 evolution



Powder coating in RAL-, HKS-, NCS- and own colours; effect finishes also possible.



The new pallet stowage box from HS-Schoch has been vested with eternal youth. Its body of hot-galvanized sheet metal with cathodic electro-dipcoated surfaces, including zinc-phosphating and powder-coating on request, is resistant to the customary aging and deterioration process. Rust doesn't stand a chance! To provide you with additional assurance in your decision in favour of HS-Schoch stowage boxes we have introduced the **6+3 Guarantee**, which warrants the box against rusting through for a period of 6 years and 3 months in accordance with our guarantee provisions.

Spare wheel box

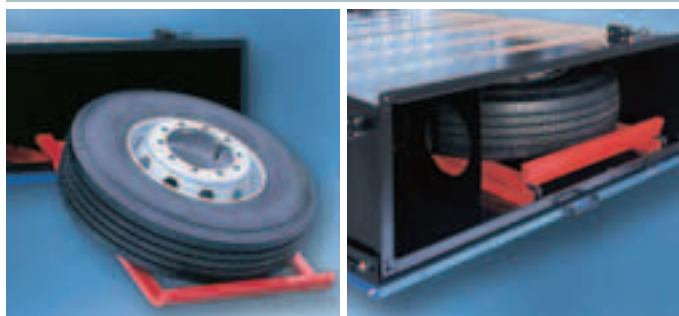

For convenient loading and unloading by one person.
Order No. **PK2000 0001**

Box for electric lift truck



With retractable loading ramp.
Suitable for mounting on articulated tow trucks or trailers.
Trailer Order No. **7175 180101**
Articulated tractor Order No. **7175 180201**

Stanchion box



Always accessible and still optimally stowed.
360x280x2.325 mm:
Order No. **7175 2320**
360x280x1.975 mm:
Order No. **7175 1975**

Joloda boxes



Well loaded means half the job done.
660x300x2.080 mm
Order No. **5812 8880**

Box for tarpaulins/nets

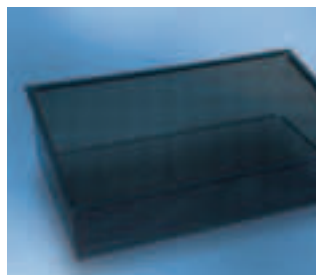

For container vehicles
600x290 mm/360x500 mm
Order No. **7206 0506**
1.000x210 mm/310x600 mm
Order No. **7206 0606**

Tool box



Individual sizes and versions.
Order No. **7100 0000**

PU-Boxes

Tool box 101	440 mm x 400 mm x 480 mm	Order No. 4000 0020
Tool box 102	600 mm x 450 mm x 480 mm	Order No. 4000 0021
Tool box 103	750 mm x 430 mm x 450 mm	Order No. 4000 0022
Tool box 104	750 mm x 430 mm x 550 mm	Order No. 4000 0023
Tool box 105	1040 mm x 490 mm x 480 mm	Order No. 4000 0024
Tool box 106	750 mm x 290 mm x 450 mm	Order No. 4000 0025
Tool box 107 with carrier for cross-type socket wrench	680 mm x 670 mm x 530 mm	Order No. 4000 0026
Triangular bracket to be mounted on chassis		Order No. 4000 0030
Fire extinguisher box 200 For 6kg and 9kg fire extinguisher		Order No. 4000 0029
Fire extinguisher box 155	313 mm x 674 mm x 257 mm	Order No. 4000 0035
Fire extinguisher box 150	1040 mm x 490 mm x 480 mm	Order No. 4000 0028



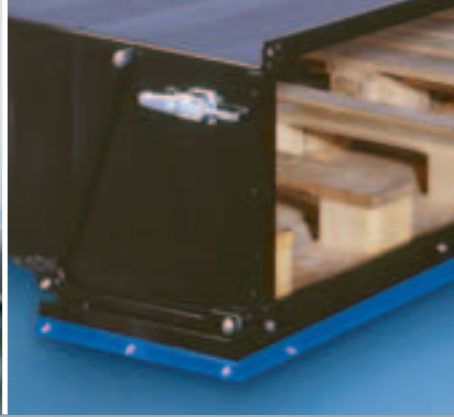

www.hs-schoch.de

HS Schoch

Truck accessories/truck styling

- Aerokits
- Bull-catchers
- Cabin steps
- Compressed air fanfares
- Consoles
- Floor mats
- High-tops
- Root-wood trim
- Side window wind deflector
- Side panelling
- Sidepipes
- Sleeping pods
- Spare wheel carrier
- Spotlamp brackets
- Stowage boxes
- Sun vizors
- Wheel accessories
- Work platforms