



DAF & HS-Schoch:

This must be love.

HS Schoch
Truck accessories/truck styling



This must be love.



Being a trucker means much more than just driving day after day from A to B and back via C. Being a TRUCKER means your job is your vocation in life.

For a real truck driver, his truck is not only his workplace or tool, it is his »home from home«, his daily companion.

En route on strange roads in foreign countries, his truck is often his only comrade in the long lonely nights.

No wonder real attachment grows. Two that belong together can get very close.

And of course every driver wants to be seen on the road with a truly attractive companion. One that is so eye-catching that it steals the show from other road-users.

For all this and more, **HS-Schoch** is the right address. Especially our exclusive stainless steel range makes trucker hearts beat faster – and converts »dull«, often inconspicuous trucks into true personalities.

Bull-catchers, lamp brackets, sidepipes, wheel accessories and compressed air horns made of finest V2A stainless steel ensure you make a distinctive, spectacular impact.

This catalog also contains high tops, cab bunks, spoilers, sun-screens, stowage facilities and a huge range of other practical articles which aim at making life easier and ensuring your safety on the highway.

**All based on the HS-Schoch motto:
»Quality over price«**

You're in for a pleasant surprise.

HS Schoch

Truck accessories/truck styling





XF 105	15
XF, 95 XF, 95	6 7
CF, LF, 45	8 9
PK2000 evolution	10 11
EK1000, HS-Gruppe	12 13
Made by HS-Schoch	14 15





The readers of **FERNFAHRER**, **lastauto omnibus** and **trans aktuell** have chosen our company as the **»best tuning & styling brand«** for the second time in a row.

We consider this prestigious award a confirmation and an acknowledgment of our work. At the same time, this award is an incentive for us to do all we can to keep you as our clients satisfied in the future.

True to our motto **»quality beats price«** we aim to continue offering you top quality and service at an attractive price.

This is what we are striving for.

Best regards

A handwritten signature in blue ink, appearing to read 'H. Schoch'.

Hermann Schoch



Made for DAF

XF 105

All stainless **steel parts** are mirror-polished by hand.

Wheel accessories are shown on page 617.

Spare wheel carrier and a wide selection of stowage boxes are shown on page 1011112.

Bull-catcher V2A stainless steel, \varnothing 76 mm. Mounting on original points. TÜV certification



XF 105 MEGA Order No. 5002 3326



XF 105 STANDARD Order No. 5002 3328

Spotlamp brackets V2A stainless steel, without Spotlamp



MEGA SuperSpaceCab Order No. 1650 3051



SuperSpaceCab Order No. 1650 3052



SpaceCab top Order No. 1650 3007



bottom Order No. 1650 4009

V2A stainless steel, 4 Mounting Brackets for Spotlamp, \varnothing 60 mm. Without Spotlamp.

Cabin Steps Set V2A stainless steel

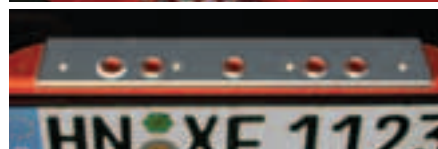

Cabin steps (3-pieces) Order No. 1653 0020
Front step Order No. 1653 0105
 side panelling (2-pieces) Order No. 1653 0106

Sidepanelling A2000



Wheel base 3.600 mm, Low Truck
 Order No. 2006 0136
Wheel base 3.800 mm, Low Truck
 Order No. 2006 0138/L

Consoles



Telematics root-wood
 Order No. 1021 0108
Telematics black
 Order No. 1021 0107



centre black
 Order No. 1021 0101
centre root-wood
 Order No. 1021 0102



right root-wood
 Order No. 1021 0114
right black
 Order No. 1021 0113



XXL right black
 Order No. 1021 0115
XXL right root-wood
 Order No. 1021 0116
 not together with driver's console table



More than a feeling

Truck-styling puts your truck in the limelight, turning it into an impressive visiting card its owner can be proud of.

Floor mats



XF/95 XF Set right/links black/red/blue
Order No. **1020 0127**

Sun vizor XF/95 XF



XF/95 XF special with support SpaceCab Order No. **1700 5065**

Wind deflector

XF/95 XF Order No. **5001 0022**

Consoles XF/95 XF



centre black
Order No. **1021 0101**
centre root-wood
Order No. **1021 0102**



right root-wood
Order No. **1021 0104**
right black
Order No. **1021 0103**



Telematics root-wood
Order No. **1021 0108**
Telematics black
Order No. **1021 0107**



XXL right black not together with driver's console table
Order No. **1021 0105**
XXL right root-wood
Order No. **1021 0106**

Wheel nut caps



RMK 27: **1650 1090**
RMK 30: **1650 1100**
RMK 32: **1650 1210**
RMK 33: **1650 1310**
Lamp cowling
1650 3000

Root-wood trim XF/95 XF



XF root-wood trim 18-pieces No. **1020 0031**
95 XF root-wood trim 12-pieces
Order No. **1020 0025**

Truck interior outfits also available in carbon fibre, aluminium and fashion look. Ask us.

Spotlamps V2A stainless steel, light bulb not included



Bosch Navigator Ø211 mm, code no. 37,5
clear Order No. **3674 1526** **blue** No. **3674 1527**
Worklamp without code number
clear Order No. **3674 1528**



HELLA Luminator Chromium Celis, Spotlight with LED sidelight ring, Ø 224mm, code no. 37,5
clear Order No. **3674 3211**
HELLA Rallye 3000 Blue, code no. 30: **3674 3221**

Stainless steel adapter plate for HELLA Luminator
Chromium Celis Spotlamp bar **bottom** Order No. **1650 02998**
Clamp fitting for mounting spotlamp
60mm Order No. **2000 1430** 76mm Order No. **2000 1431**

Hub caps



Hub cap normal
50mm **1650 2000**
centre 170mm
Steel rim **1650 2021**
Alu rim **1650 2022**
hoch 240mm
Steel rim **1650 2016**
Alu rim **1650 2017**

Cover rings



Cover ring, closed
For aluminium + steel rim
6-hole 17,5": **1650 1802**
8-hole
17,5"+19,5": **1650 1805**
Steel rim
22,5": **1650 1800**
Alu rim
22,5": **1650 1801**



Cover ring, open
For aluminium + steel rim
17,5": **1650 1806**
Steel rim
22,5": **1650 1803**
Alu rim
22,5": **1650 1804**

wheel liners



wheel liners
(without cover ring)
22,5" Standard, with fixing ring, depth 40mm
8060 42090

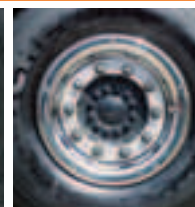

wheel liners at the rear
22,5" Exklusive, with fixing ring, depth 80mm
8060 42095

Ornamental hub caps

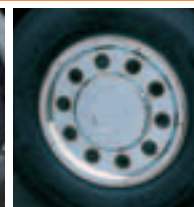

Ornamental hub cap Rear axle
17,5": **8060 32045**
19,5": **8060 32035**
22,5" Rear axle & Super Single front:
8060 32055

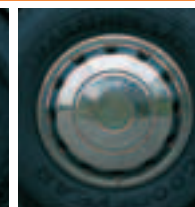

Ornamental hub cap Front axle
17,5": **8060 32040**
19,5": **8060 32030**
22,5": **8060 32050**



All stainless **steel parts** are mirror-polished by hand.

Side panelling A2000 on page 415.

Spare wheel carrier and a wide selection of stowage boxes are shown on page 1011112.

Bull-catcher V2A stainless steel, \varnothing 76 mm. Mounting on original points. TÜV certification



XF/95 XF MEGA
Order No. **5002 3218**



XF/95 XF STANDARD
Order No. **5002 3216**
95 STANDARD Order No. **5002 3214**

Cabin Steps Set V2A stainless steel



Cabin steps (3-pieces) Order No. **1653 0020**
Front step Order No. **1653 0105**
side panelling (2-pieces) Order No. **1653 0106**

fully rotating lamp



Order No. **2RL00806 1111**
Fixing plate for all-round light, with clamp
Order No. **1650 2999**

Sidepipe



XF/95 XF
single outlet No. **1650 5006**
dual outlet No. **1650 5015**
V4A stainless steel

Compressed air horns*



Original HS 67+76 cm
Order No. **5000 0000**
Super fanfare Typ BEAM
80+85 cm **5121 7701**
65+70 cm **5121 7702**
*complete kit, incl. Pullswitch Valve

Spotlamp brackets V2A stainless steel, 4 Mounting Brackets for Spotlamp, \varnothing 60 mm. Without Spotlamp.



Spotlamp bar **roof**
XF/95 XF SuperSpaceCab
Order No. **1650 3027**



Spotlamp bar **roof**
XF/95 XF SpaceCab
Order No. **1650 3007**



Spotlamp bar **bottom** **XF/95 XF**
Order No. **1650 4009**

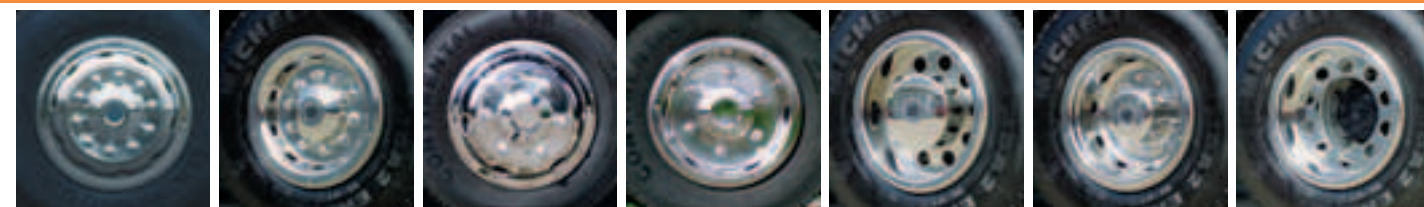

Ornamental hub cap Grand Prix, Front axle
22,5": **8060 42050**

Ornamental hub cap Grand Prix, Rear axle
22,5": **8060 42055**

Ornamental hub cap at the front
Grand Prix
19,5" with fixing ring
8060 42030
17,5" with fixing ring
8060 42040

Ornamental hub cap at the rear
Grand Prix,
19,5" with fixing ring
8060 42035
17,5" with fixing ring
8060 42045

Ornamental hub cap at the rear
22,5" Exklusive,
10-hole
with fixing ring,
depth 130mm
8060 42065

Ornamental hub cap at the rear
22,5" Exklusive,
with wheel nut caps,
with fixing ring
8060 42075

Ornamental hub cap at the rear
22,5" open, with fixing ring
8060 42080



Your Truck – your style

You will be recognized by your truck. Bull-catchers, lamp brackets, sidepipes and numerous other accessories give standard trucks real character.

Bull-catcherr CF V2A stainless steel, ø 60 mm. TÜV certification



Bull-catcherr **STANDARD** Order No. **5002 3222**

Consoles CF



centre black Order No. **1021 0151**
centre root-wood Order No. **1021 0152**



right root-wood Order No. **1021 0154**
right black Order No. **1021 0153**

Sleeping pods

DAF 45

Typ N Built-on cab
 (VA 400/435) Order No. **21001 30400**

Typ K Built-on cab
 Order No. **21002 30409**

Wheel nut caps



RMK 27: **1650 1090**
 RMK 30: **1650 1100**
 RMK 32: **1650 1210**
 RMK 33: **1650 1310**
Lamp cowling
1650 3000

Compressed air horns complete kit



Super fanfare Typ BEAM
 80+85 cm Order No. **5121 7701**
 65+70 cm Order No. **5121 7702**

Original HS
 67+76 cm Order No. **5000 0000**

Spotlamp brackets CF V2A stainless steel, ø 60 mm*



Flat roof **top** Order No. **1650 4016**
bottom Order No. **1650 3032**

*4 Mounting Brackets for spotlamps, without spotlamps.
 Spotlamping on page 4/5

Hub caps



Hub cap normal
 50mm **1650 2000**
centre 170mm
 Steel rim **1650 2021**
 Alu rim **1650 2022**
hoch 240mm
 Steel rim **1650 2016**
 Alu rim **1650 2017**

Cover rings



Cover ring, closed
 For aluminium + steel rim
6-hole 17,5": **1650 1802**
8-hole
 17,5"+19,5": **1650 1805**
Steel rim
 22,5": **1650 1800**
Alu rim
 22,5": **1650 1801**



Cover ring, open
 For aluminium + steel rim
 17,5": **1650 1806**
Steel rim
 22,5": **1650 1803**
Alu rim
 22,5": **1650 1804**

wheel liners



wheel liners
 (without cover ring)
 22,5" Standard,
 with fixing ring,
 depth 40mm
8060 42090

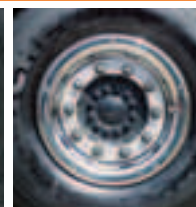

wheel liners at the rear
 22,5" Exklusive,
 with fixing ring,
 depth 80mm
8060 42095

Ornamental hub caps

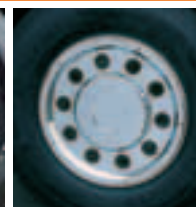

Ornamental hub cap Rear axle
 17,5": **8060 32045**
 19,5": **8060 32035**
 22,5" Rear axle &
 Super Single front:
8060 32055

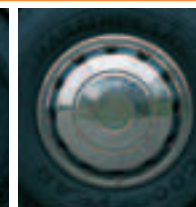

Ornamental hub cap Front axle
 17,5": **8060 32040**
 19,5": **8060 32030**
 22,5": **8060 32050**



All stainless **steel parts** are mirror-polished by hand.

Spare wheel carrier and a wide selection of stowage boxes are shown on page 1011112.

Sun vizor LF



small special with support
Order No. **1700 5171**



large special with support
Order No. **1700 5170**

Sleeping pods LF



Typ N short cab
Order No. **21000 130310**

Typ N long cab
Order No. **21000 130311**

3-D roof spoiler LF



Typ N short cab
Order No. **16000 50024**



Typ N long cab
Order No. **16000 50025**

3-D roof spoiler CF



short low cab
700 mm – 900 mm
Order No. **16001 12410**

Side panelling CF 75,
short and long low cab
Order No. **16001 12450**

Side panelling CF 85,
short and long low cab
Order No. **16001 12460**



CF 85, Space Cab,
for Side elements (orig. also) Order No. **16001 17800**

CF 75, Space Cab,
for Side elements (orig. also) Order No. **16001 17810**

CF 75/85, Space Cab
Order No. **16001 17820**

CF 85, Side panelling
Order No. **16001 17840**

CF 75, Side panelling
Order No. **16001 17830**

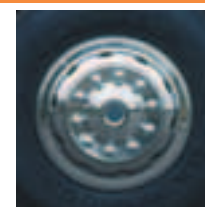

Ornamental hub cap Grand Prix,
Front axle
22,5": **8060 42050**



Ornamental hub cap Grand Prix,
Rear axle
22,5": **8060 42055**



Ornamental hub cap at the front
Grand Prix
19,5" with fixing ring
8060 42030
17,5" with fixing ring
8060 42040



Ornamental hub cap at the rear
Grand Prix,
19,5" with fixing ring
8060 42035
17,5" with fixing ring
8060 42045



Ornamental hub cap at the rear
22,5" Exklusive,
10-hole
with fixing ring,
depth 130mm
8060 42065



Ornamental hub cap at the rear
22,5" Exklusive,
with wheel nut caps,
with fixing ring
8060 42075



Ornamental hub cap at the rear
22,5" open, with fixing ring
8060 42080



All aboard

No journey can really start until everything is »on board«. And in a context applicable for freight traffic, the proverb »As you make your bed, so you must lie in it« could be adapted to »As you load your truck, so you will travel«. To ensure that you can travel the roads of Europe safely and with confidence, **HS-Schoch** have developed perfect stowage systems you can rely on.

Pallet stow box PK2000 evolution light empty weight, low structural height and long service life; TÜV certification

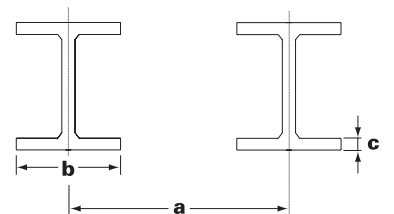
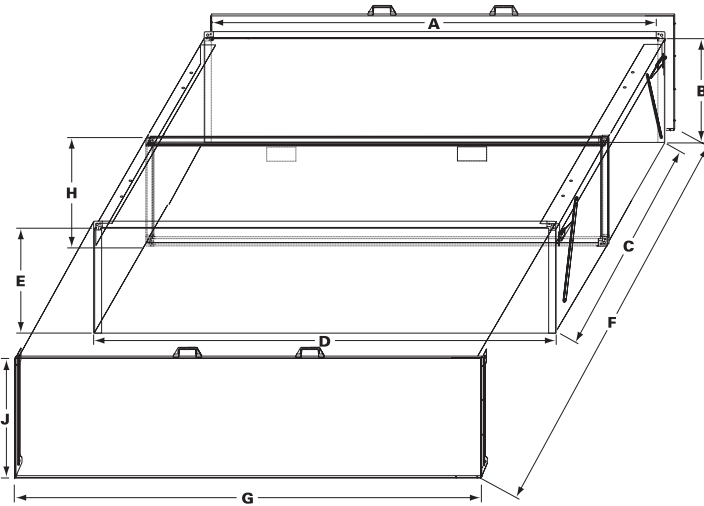
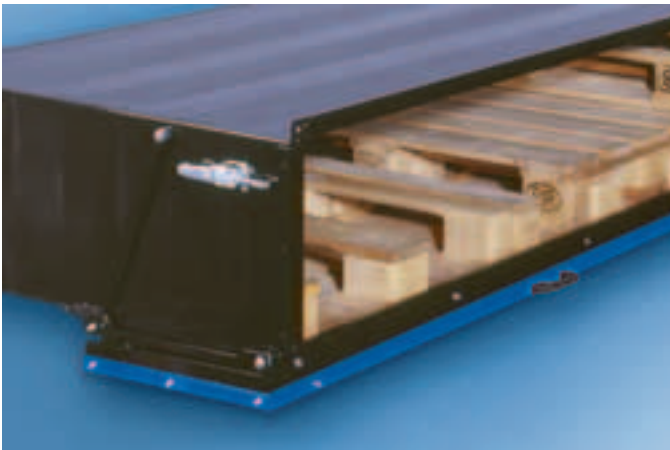

Drilling dimensions/Installation instructions:

Please specify the three dimensions shown in the sketch when you place your order: (a) = centre-to-centre distance between frame members; (b) = lower flange width; (c) lower flange thickness. The stretch clamps supplied allow you to bolt the boxes underneath any trailer or semi-trailer.

Measure H:

Dimension from lower edge of member to lower edge of pallet storage box.

Dimension E:

Protracted dimension from bottom edge of support to pallet storage box in loading range.

Order No.	Designation	A	B	C	D	E	F	G	H	J
PK20000800E1	PK 08 EP	1230	450	2450	1310	482	2490	1351	500	550
PK20000803E1	PK 08 EPL	1520	450	2450	1600	482	2490	1641	500	550
PK20001600E1	PK 16 EP	1960	450	2450	2040	482	2490	2081	500	550
PK20002000E1	PK 20 EP	2460	450	2450	2540	482	2490	2581	500	550
PK20002400E1	PK 24 EP	2630	450	2450	2710	482	2490	2751	500	550
PK20002401E1	PK 24 EPK	1960	605	2450	2040	637	2490	2081	655	700
PK20003000E1	PK 30 EP	2630	560	2450	2710	592	2490	2751	610	650
PK20003001E1	PK 30 EPK	2460	605	2450	2540	637	2490	2581	655	700
PK20003200E1	PK 32 EP	3430	450	2450	3510	482	2490	3551	500	550
PK20003600E1	PK 36 EP	2630	605	2450	2710	637	2490	2751	655	700



PK2000 evolution



Powder coating in RAL-, HKS-, NCS- and own colours; effect finishes also possible.



The new pallet stowage box from HS-Schoch has been vested with eternal youth. Its body of hot-galvanized sheet metal with cathodic electro-dipcoated surfaces, including zinc-phosphating and powder-coating on request, is resistant to the customary aging and deterioration process. Rust doesn't stand a chance! To provide you with additional assurance in your decision in favour of HS-Schoch stowage boxes we have introduced the **6+3 Guarantee**, which warrants the box against rusting through for a period of 6 years and 3 months in accordance with our guarantee provisions.

Spare wheel box

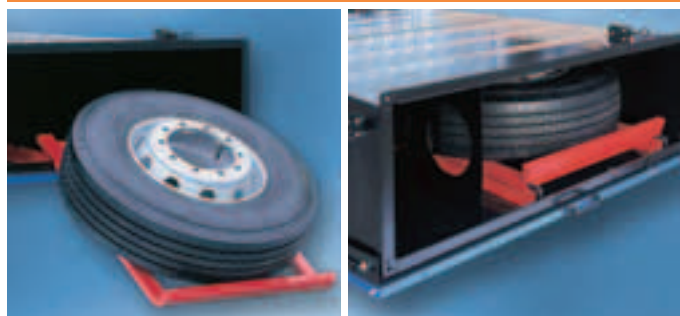

For convenient loading and unloading by one person.
Order No. **PK2000 0001**

Box for electric lift truck



With retractable loading ramp.
Suitable for mounting on articulated tow trucks or trailers.
Trailer Order No. **7175 180101**
Articulated tractor Order No. **7175 180201**

Stanchion box



Always accessible and still optimally stowed.
360x280x2.325 mm:
Order No. **7175 2320**
360x280x1.975 mm:
Order No. **7175 1975**

Joloda boxes



Well loaded means half the job done.
660x300x2.080 mm
Order No. **5812 8880**

Box for tarpaulins/nets

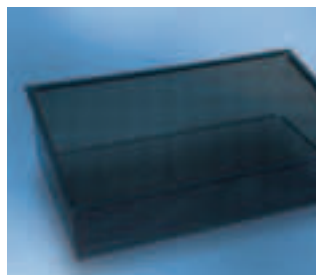

For container vehicles
600x290 mm/360x500 mm
Order No. **7206 0506**
1.000x210 mm/310x600 mm
Order No. **7206 0606**

Tool box



Individual sizes and versions.
Order No. **7100 0000**

PU-Boxes

Tool box 101	440 mm x 400 mm x 480 mm	Order No. 4000 0020
Tool box 102	600 mm x 450 mm x 480 mm	Order No. 4000 0021
Tool box 103	750 mm x 430 mm x 450 mm	Order No. 4000 0022
Tool box 104	750 mm x 430 mm x 550 mm	Order No. 4000 0023
Tool box 105	1040 mm x 490 mm x 480 mm	Order No. 4000 0024
Tool box 106	750 mm x 290 mm x 450 mm	Order No. 4000 0025
Tool box 107 with carrier for cross-type socket wrench	680 mm x 670 mm x 530 mm	Order No. 4000 0026
Triangular bracket to be mounted on chassis		Order No. 4000 0030
Fire extinguisher box 200 For 6kg and 9kg fire extinguisher		Order No. 4000 0029
Fire extinguisher box 155	313 mm x 674 mm x 257 mm	Order No. 4000 0035
Fire extinguisher box 150	1040 mm x 490 mm x 480 mm	Order No. 4000 0028





Simple and secure ...

EK1000 spare wheel carrier from HS-Schoch

- Simple to mount on the trailer framework
- Simple to fasten and remove the spare wheel
- Highly reliable and strong due to using square sections
- Fits on practically all types of trailer
- Two wheel carriers can be mounted at the same time
- Excellent corrosion protection by cathodic electro-dipcoating and zinc phosphating
- Powder-coated in RAL 9005 – other RAL colors available on request
- Available for 22.5" wheels with and without offset
- Total weight 22 kg



Spare wheel carrier EK1000 for 22,5" wheel liner Order No. **2100 6120**
 Clamping range 320mm Order No. **2100 6320**
 Clamping range 220mm Order No. **2100 6220**

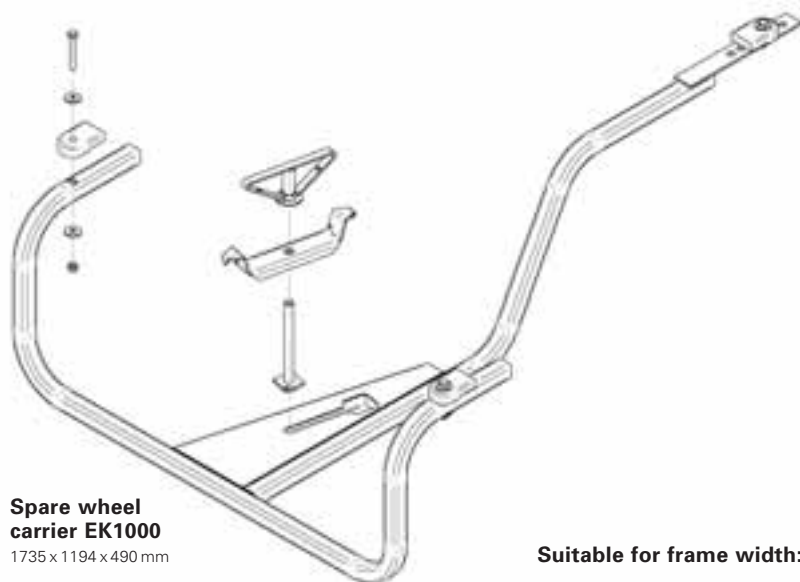

Spare wheel carrier EK1000
 1735 x 1194 x 490 mm

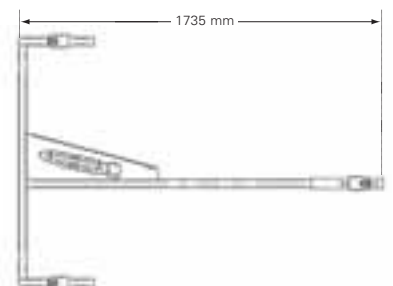

Suitable for frame width:

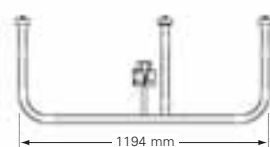
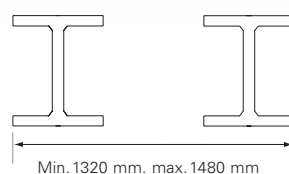

HS Gruppe

www.hs-gruppe.com

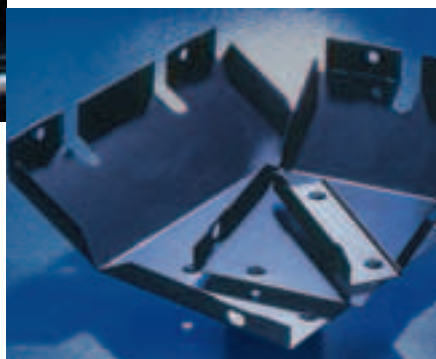
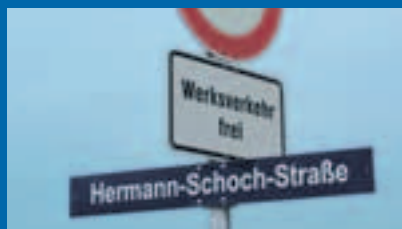

HS-Schoch GmbH
Truck accessories/truckstyling
73466 Lauchheim, Germany

HS-Schoch GmbH
Distribution North
49439 Mühlen, Germany

HS-Schoch GmbH
Sheet metal working
Cathodic electro dipcoating /
powder coating
06869 Cobbelsdorf, Germany



HS-Schoch e.K.
Accessories for
Earth-moving machines
73466 Lauchheim, Germany

HS-Schoch e.K.
Accessories for
Construction machines
06869 Cobbelsdorf, Germany



BKT GmbH
GRP-production
Polyurethan-production
Deepdrawing (ABS, PS, PC)
38112 Braunschweig, Germany

Tarmetec
Sheet Accessories
Car Industry
EE 50303 Tartu, Estonia

Made by HS-Schoch



Even in times like these when the range of products is more diversified and extensive than ever before, it is important to know who one is dealing with.

With **HS-Schoch** you are always on the safe side. Take advantage of our long experience and our know-how in truck accessories that we have acquired and advanced over the years.

Our products are developed in close cooperation with the manufacturers of utility vehicles, ensuring that our accessories are optimally coordinated to the specific vehicles and comply with the latest design and safety standards.

All **HS-Schoch** bull-catchers, lamp brackets, sidepipes, etc. have been developed and are produced in our own works.

This ensures that you are always close to base.

Especially our stainless steel range will give your truck that special "plus" and is guaranteed to attract attention. Quality workmanship and top design, with everything mirror-polished by hand make sure of that.

But these are only a few of the reasons for choosing products from **HS-Schoch**.

HS-Schoch means quality at fair prices. And our high standard of quality extends not only to our products, but also to our service.

With us, you are definitely on the safe side.



HS Schoch

Truck accessories/truck styling

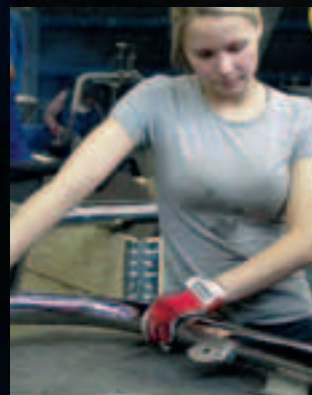

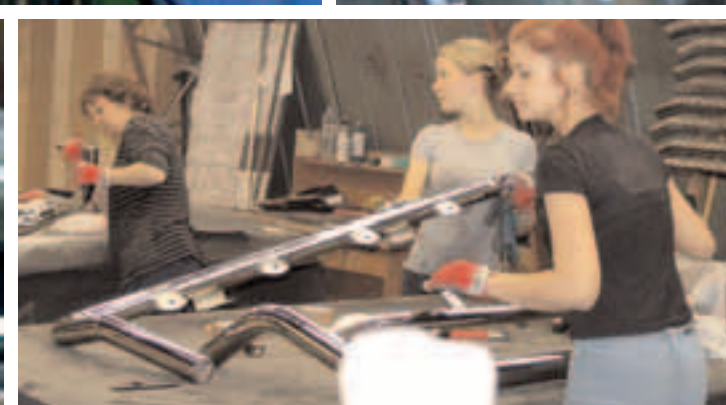
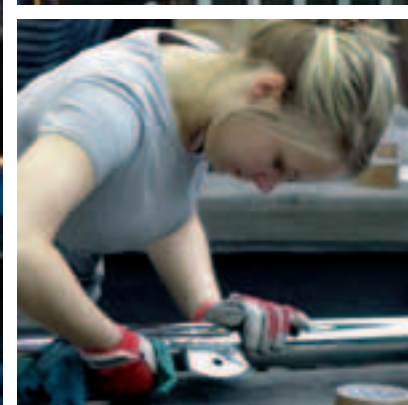
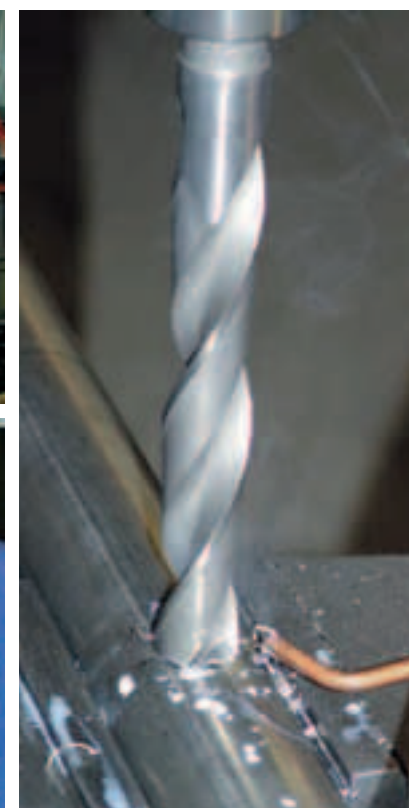
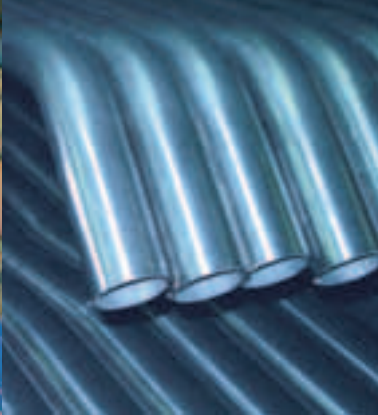

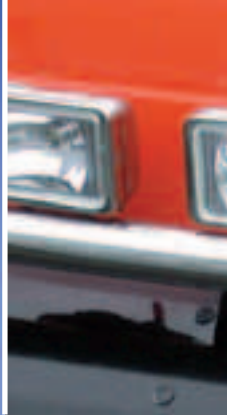

www.hs-schoch.de

HS Schoch

Truck accessories/truck styling

- Aerokits
- Bull-catchers
- Cabin steps
- Compressed air fanfares
- Consoles
- Floor mats
- High-tops
- Root-wood trim
- Side window wind deflector
- Side panelling
- Sidepipes
- Sleeping pods
- Spare wheel carrier
- Spotlamp brackets
- Stowage boxes
- Sun vizors
- Wheel accessories
- Work platforms